



CHARGER

Operating Instructions

CHARGER 440B v1.0

Microprocessor controlled high performance **Charger / Discharger / Balancer / Cell Monitor** for LiPo & LiFe battery packs.

Charge Rate 0.1-4.0A, 35W, for 2-4 LiPo & LiFe cells



Chargery Power Co., Ltd.

Head Office

Add: Room 20B, Haihui building, Nanhai Avenue, NanShan, ShenZhen, China

Zip code: 518054

Tel: +86 755 2643 6165

Fax: +86 755 2641 2865

Email: admin@chargery.com.cn

Web: www.chargery.com

Welcome to CHARGER CY-440B intelligent balance charger designed especially for 2 to 4 LiPo & LiFe cells. Please read the following instructions carefully before using the charger.

Special Features

■ **Built-in cell balancer for LiPo and LiFe cells**

The CY-440B has a built-in individual cell balancer. LiPo or LiFe batteries are automatically balanced during charge. When the battery is fully charged, it will be also properly balanced.

■ **High power and high performance circuit**

CY-440B employs the high efficiency circuit. Therefore it can charge 4S LiPo/LiFe cells with maximal current of 4.0A, and the case is only 103*70*25mm. It is easy to take and convenient to use.

■ **Balance cell voltage while discharge—balance Discharge**

CY-440B can balance LiPo and LiFe cells in battery pack while discharge, at the same time adjustable terminal cell voltage is more convenient for special application.

■ **Input power monitor**

To protect the car battery using as input power from being damaged, the input voltage will be always monitored. If it is under 10.0V, the charging process will be stopped automatically.

At the same time, when you use the AC adaptor or transformer as input power, if the input voltage over 15V, the charging process will be terminated to protect the CY-440B from being damaged.

■ **Reverse polarity and short circuit protection (input and output)**

■ **Over charge and Over current protection**

■ **Light and attractive AL alloy case**

■ **LCD with back-light displaying total battery pack voltage, cell voltage, difference of cell voltage, running time, charge current and so on.**

Specifications

■ **Applied battery type: LiPo & LiFe battery**

■ **Cell count: 2~4 cells**

■ **Input voltage: DC 10-18V, 5.0A**

■ **Charge current: 0.1~4.0A, 35W max.**

■ **Discharge current: 300mA max.**

■ **Balancing current: 300mA max.**

■ **Balance precision:10mV**

■ **Display resolution:0.001V**

■ **Detect precision:0.005V**

■ **Dimension:103*70*25mm**

■ **Weight:170g**

Charger interface



Program flow chart

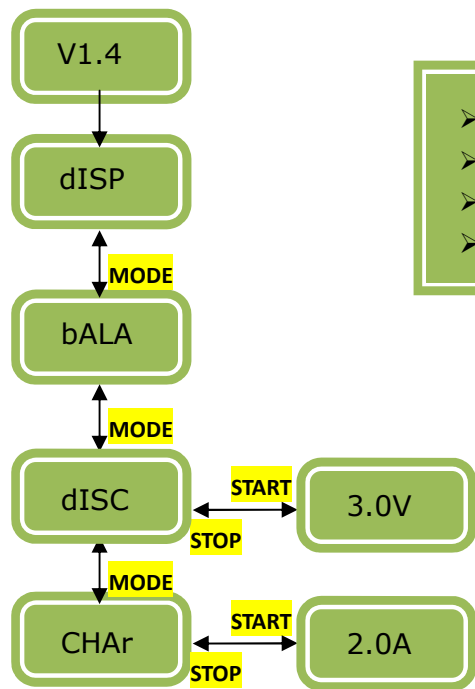

- **dISP**: cell monitor mode
- **bALA**: balance mode
- **dISC**: discharge mode
- **CHAr**: balance charge

Press **SET** button set up the cell terminal voltage when discharge, range from 2.0~3.6V for LiFe, default:2.0V, and 3.0~4.2V for LiPo, default: 3.0V.

Press **SET** button set up the charge current, range from 0.5~9.9A, default: 2.0A.

Note:

When you turn off the charger, it will remember the current setup and recall it when next turned on again.

Detect and display LiPo/LiFe battery at DISP mode

At dISP mode, press **START** button, 440B will detect and display LiPo/LiFe cell status, including cell voltage, total pack voltage, difference of voltage, battery gauge.

Press **SET** button stop displaying, and press again continue.

Press **STOP** button stop detecting and return main menu.

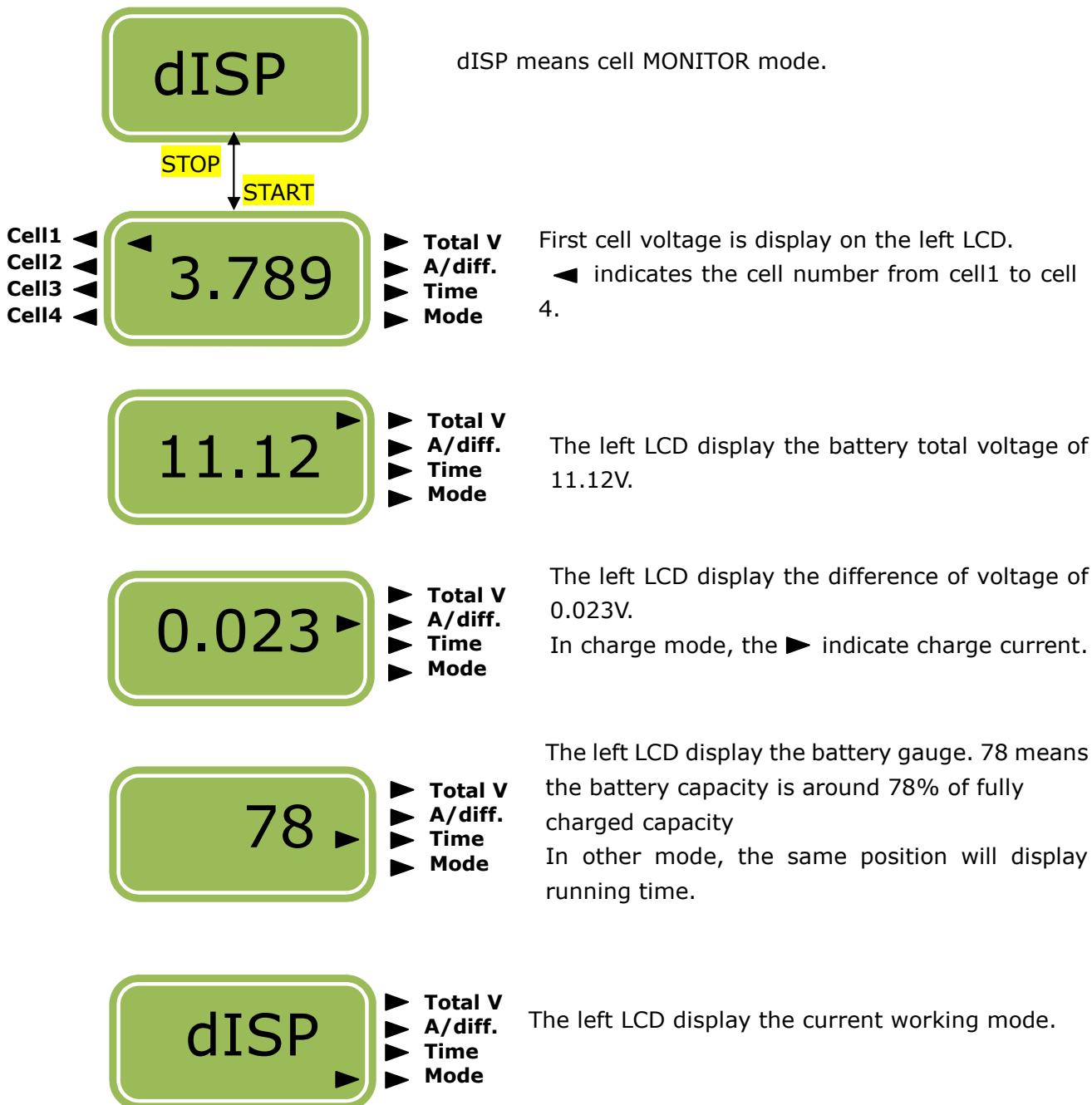

Balance LiPo/LiFe battery at bALA mode

At bALA mode, press **START** button, 440B will work as a smart balancer, the high voltage cell will be discharged till the difference of cell voltage less than 10mV. The LCD will display cell voltage, total voltage, difference of cell voltage and running time, finally the battery will be balanced.

Press **SET** button stop displaying, and press again continue.

Press **STOP** button stop balancing and return main menu.

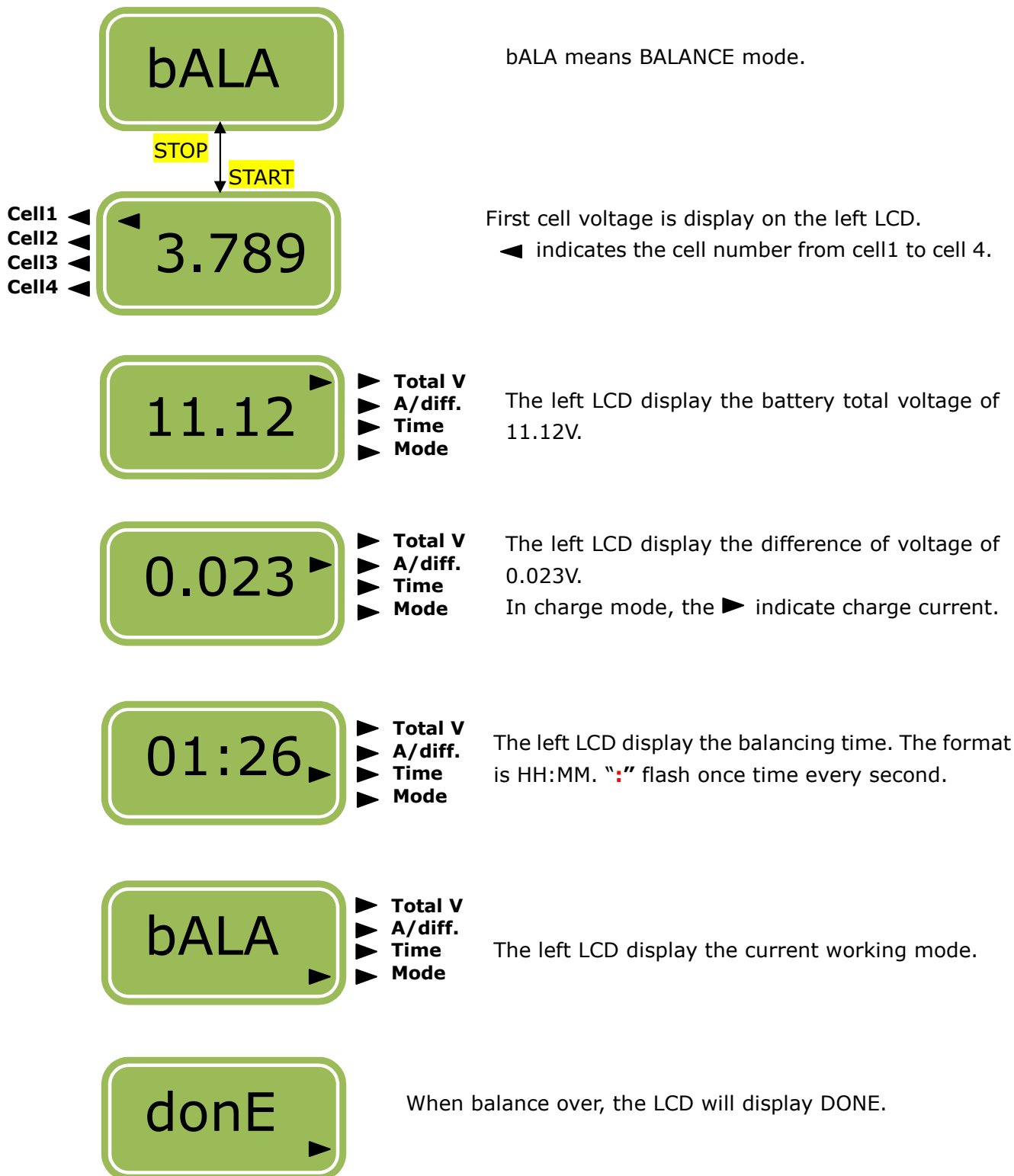

Discharge LiPo/LiFe battery at dISC mode

At dISC mode, press **START** button, 440B will discharge the battery, you can set up the cell terminal voltage, and the battery must be connected to balance port on 440B. During discharge, the LCD will display cell voltage, total voltage, difference of cell voltage and running time. It is only for LiPo and LiFe cells.

Press **SET** button stop displaying, and press again continue.

Press **STOP** button stop discharging and return main menu.

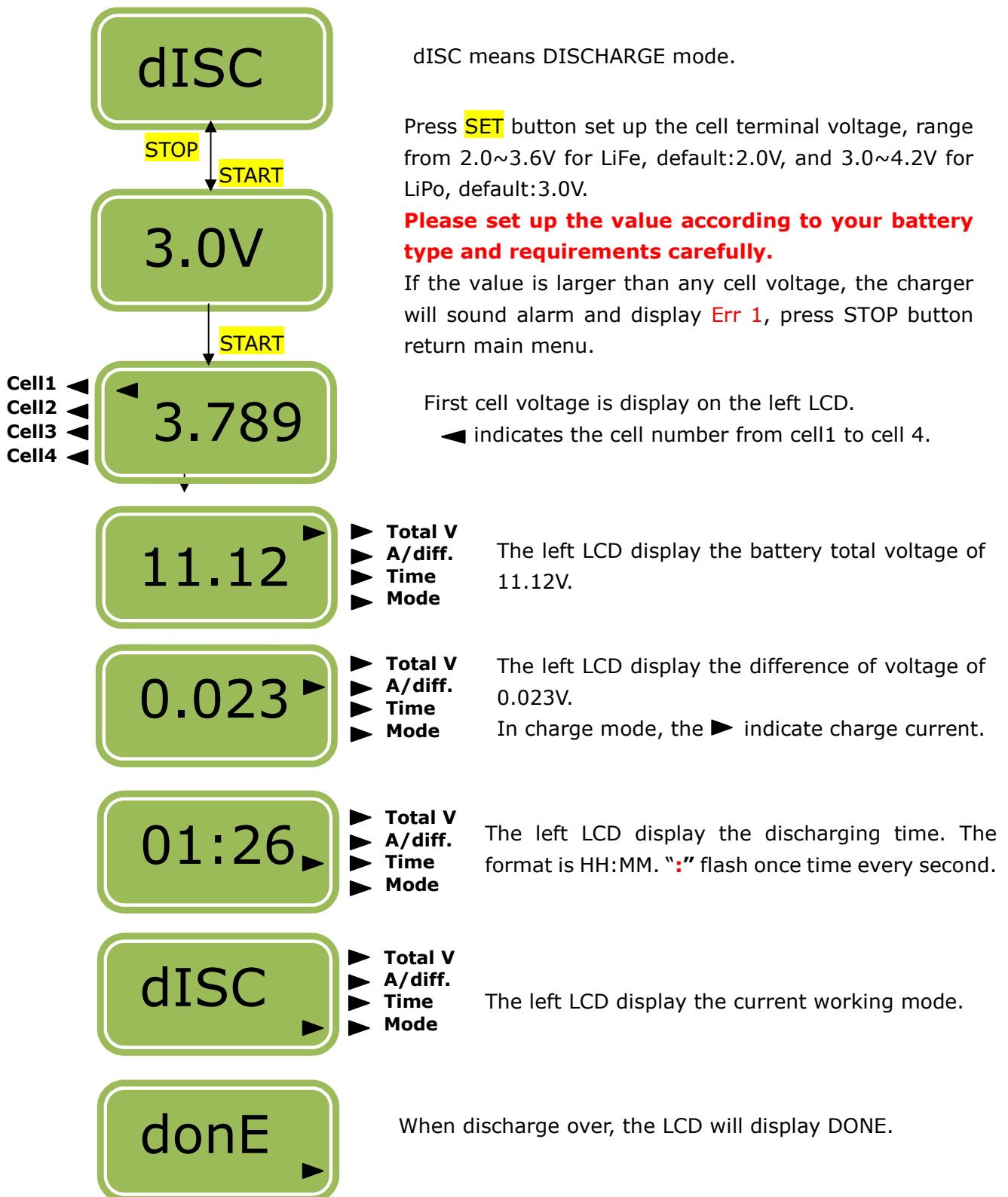

Charge LiPo/LiFe battery at CHAr mode



At this mode, press **START** button, 440B will charge the battery while balancing the battery, you can set up the charge current, and the battery must be connected to balance port on 440B. During charge, the LCD will display cell voltage, total voltage, charge current and running time. Before charge, **please move the battery type switch to the correct position.**

Press **SET** button stop displaying, and press again continue.

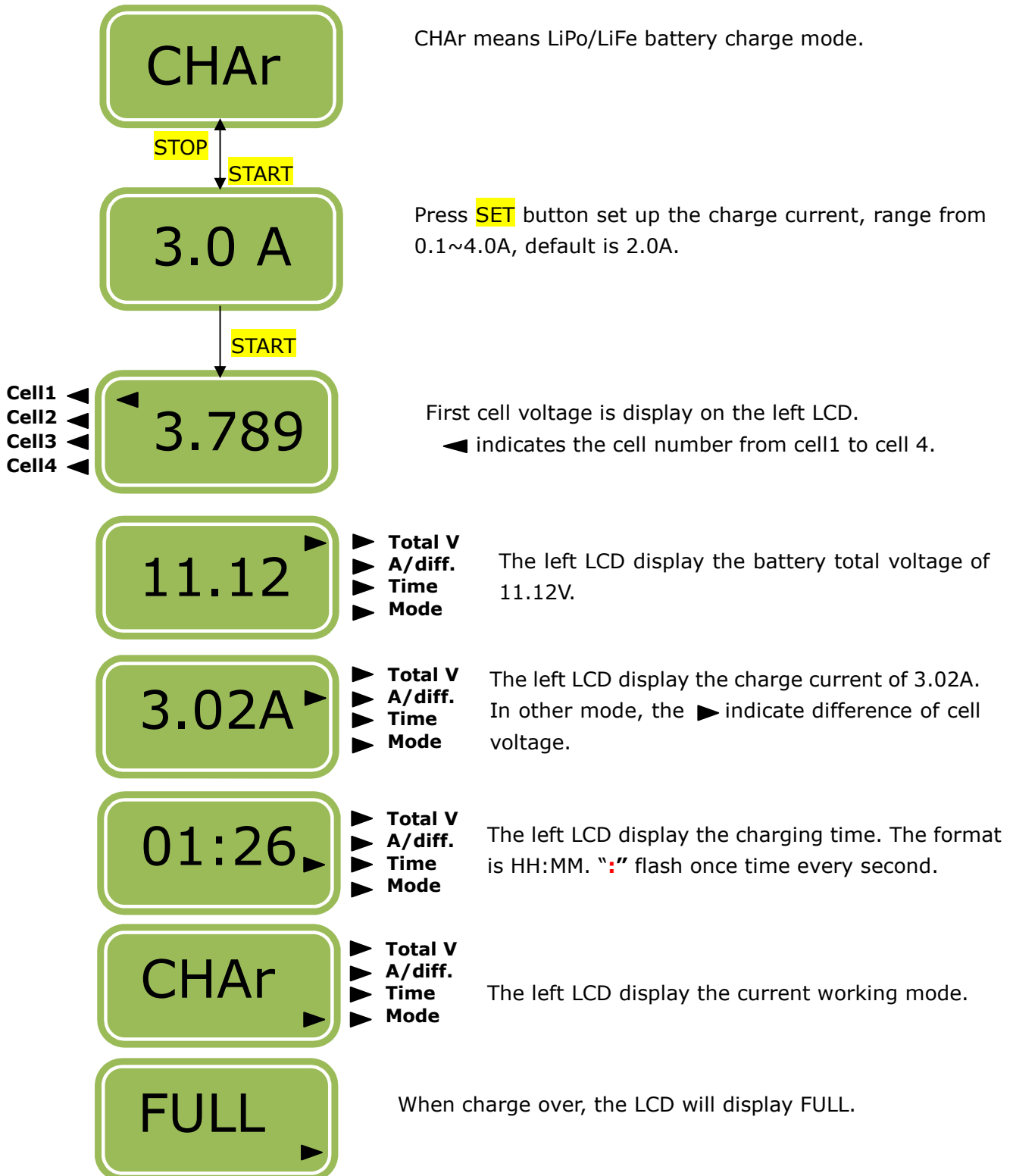
Press **STOP** button stop charging and return main menu.



The following accessories are attached with charger,

CW2 , input power leads	CEHP-5X , adapter wire	CCB-5TPQF , adapter board for 2S,3S and 4S Polyquest, Hyperion battery, and TP, FP battery
		

Maximum circuit power chart

When the battery voltage is more than 8.0V, the actual charging current delivered to the battery will be automatically limited so as not to exceed the charger's rated charging power of 35 watts. The actual feeding current will be as follows:

Maximum charge current for different battery At 50W of input power

battery type	cell counts	rated voltage(V)	Charge current(A)
LiPo	2	7.4	4.0
	3	11.1	3.2
	4	14.8	2.4
LiFe	2	6.6	4.0
	3	9.9	3.5
	4	13.2	2.7

Warning and error message

- If the battery is connected reversely, 440B will NOT work.
- In balance mode, any cell voltage is lower than 3.0V/cell (LiPo) or 2.0V (LiFe), the balance process will not be conducted.
- In Discharge mode, if the value setup is over any cell voltage, the charger will sound alarm and display **Err 1**.
- When input voltage under 10V, 440B will beep for 6 times and display **In L**.
- When input voltage over 15V, 440B will beep for 6 times and display **In H**.

Safety information

- Never leave the charger unattended when it is connected to its power supply. If any malfunction is observed immediately terminated charging and refer to the operation instructions.
- Keep away the unit from dust, damp, rain, heat direct sunshine and vibration. Do not drop it.
- The charger and the battery to be charged should be set up on a heat-resistant, non-inflammable and non-conductive surface. Never place them on a car seat, carpet or similar.
- Keep all the inflammable volatile materials well away from operating area.
- Do not attempt to charge the following types of battery:
 - Lead acid battery or VRLA
 - NIMH/NICd battery pack.
 - Any other types of battery except for li-ion and lithium polymer battery.
 - Battery pack, which consists of different types of cell (including different manufacturers).
 - Non-rechargeable batteries (Explosion hazard).
 - Faulty or damaged battery.

Those warnings and safety notes are particularly important. Please follow the instructions for a maximum safety; otherwise the charger and the battery can be damaged violently. And also it can cause a fire to injure a human body or to lose the property.

Warranty and Service

Chargery Power Co., Ltd. as manufacture of R/C model power warrants its CHARGER charger and battery pack to be free of defects in material and workmanship. This warranty is effective for 12 months from date of purchase. If within the warranty period the customer is not satisfied with the products performance resulting from a manufacturing defect the accessory will be replaced or repaired.

Your selling dealer is your first point of contact for warranty issues. Return postage costs are the responsibility of the user in all cases. Please submit copy of original receipt with the return.

Damage due to physical shock (dropping on the floor, etc.), inappropriate power supply (unstable output voltage and insufficient power, etc.), water, moisture, and humidity are specifically NOT covered by warranty. It is best to carefully check your charger before considering returning it as problems in setup, cabling, or power supply are much more common than defects in the charger. If there is damage stemming from these causes within the stated warranty period, the company will, at its option, repair or replace the charger for a service charge not greater than 50% of its then current retail list price.

Date of purchase/delivery:
Dealer:

NOTE:

CHARGER hope customers notify any change or modification made to this device.

Welcome any suggestions at admin@chargery.com.cn

Thanks and enjoy the power!

